



Brunel
University
London

Tracking detectors I: Introduction to gaseous detectors

Prof. Peter R Hobson C.Phys M.Inst.P.

Department of Electronic and Computer Engineering
Brunel University London, Uxbridge

Updated November 2015

Resources

- A recent book is Nappi E & Peskov V
Imaging gaseous detectors and their applications,
2013, ISBN 978-3-527-40898-6 - Wiley-VCH, Berlin
- The *Gas Detectors Development Group* web pages at
CERN <http://gdd.web.cern.ch/GDD/>
- For some recent information (October 2014) have a
look at the talks given at the ECFA HL-LHC meeting
under “Gaseous Detectors”
[https://indico.cern.ch/event/315626/other-
view?view=standard](https://indico.cern.ch/event/315626/other-view?view=standard)

Energy Loss in “thin” detectors

Many different ways in principle for fast charged particles to lose energy in a gas.

Only one of these, electromagnetic interactions (incoherent Coulomb) is at all probable.

Can neglect Cherenkov, bremsstrahlung, transition radiation etc.

Energy loss due to EM interactions

$$\frac{dE}{dx} = -K \frac{Z}{A} \frac{\rho}{\beta^2} \left\{ \ln \left(\frac{2m_e c^2 \beta^2 E_M}{I^2 (1 - \beta^2)} - 2\beta^2 \right) \right\}$$

$$K = \frac{2\pi N z^2 e^4}{m_e c^2}$$

Charge of projectile

Maximum energy transfer per interaction

Z , A are the atomic number and atomic mass of the medium, N is Avogadro's number and ρ is the density

“Bethe-Bloch” Formula

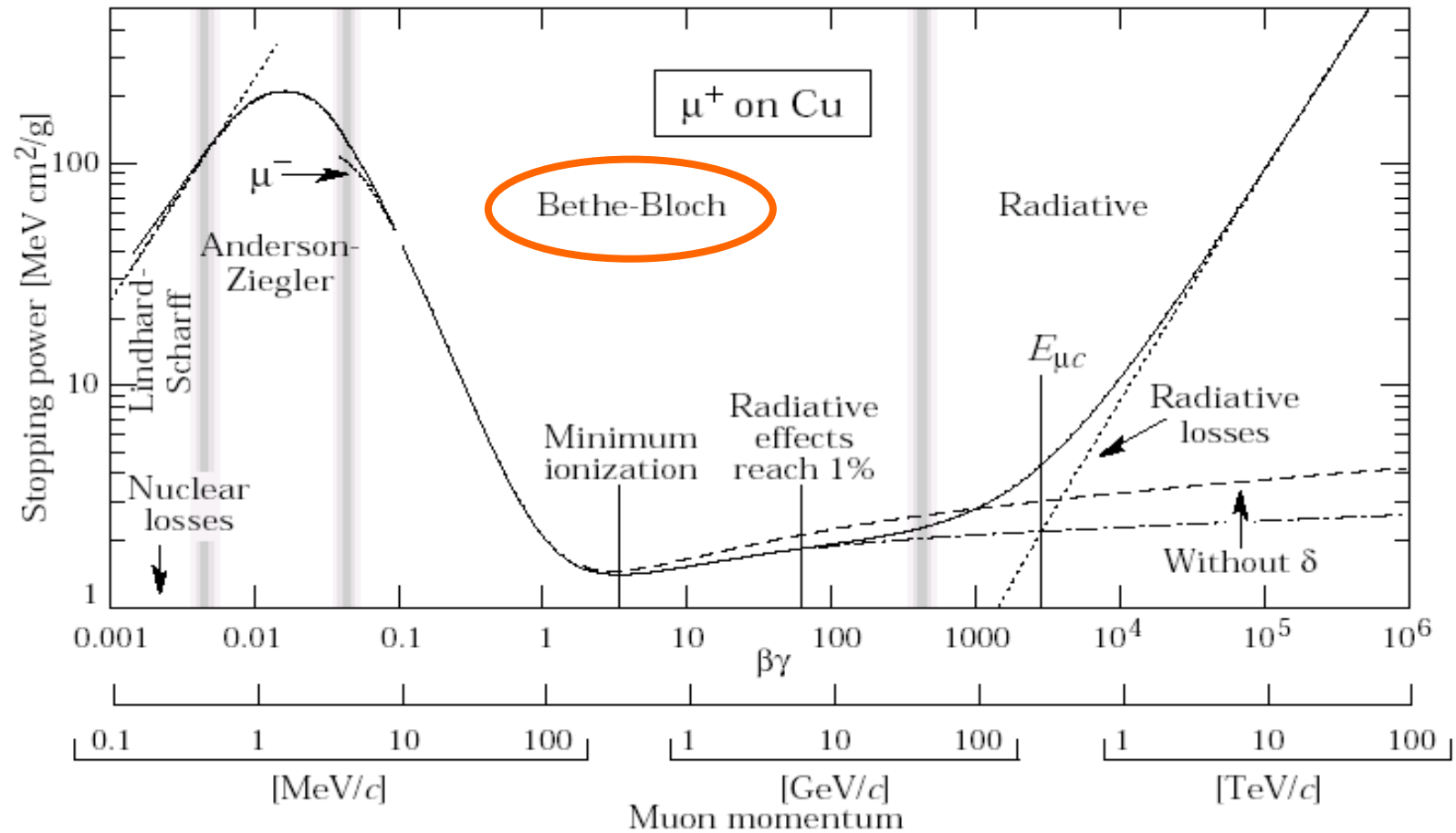

From PDG tables, see <http://pdg.lbl.gov/2002/passagerpp.pdf>

Energy loss due to EM interactions

Note the rapid fall until a minimum is reached at about $\beta \approx 0.97$. Then there is a slow “relativistic rise” as the velocity approaches c . In most materials the energy loss at the minimum is close to

$$2 \text{ MeV.g}^{-1}.\text{cm}^2$$

(hydrogen is an exception).

Gas	Z	A	MeVg ⁻¹ cm ²	keV.cm ⁻¹
H ₂	2	2	4.03	0.34
Ar	18	40	1.47	2.44
CO ₂	22	44	1.62	3.01
C ₄ H ₁₀	34	58	1.86	4.50

Energy loss

- In thin materials the energy loss is dominated by a small number of interactions each with a wide range of energy transfers allowed.
- Thus we get the classic *Landau* distribution which has a very long high energy tail and is very far from a Gaussian.
- Thus energy resolution is poor, and signals have a large dynamic range (affects design of electronics).
- To *measure* dE/dx (for particle ID) need to have a large number of independent samples.

Energy Loss in Thin Absorbers

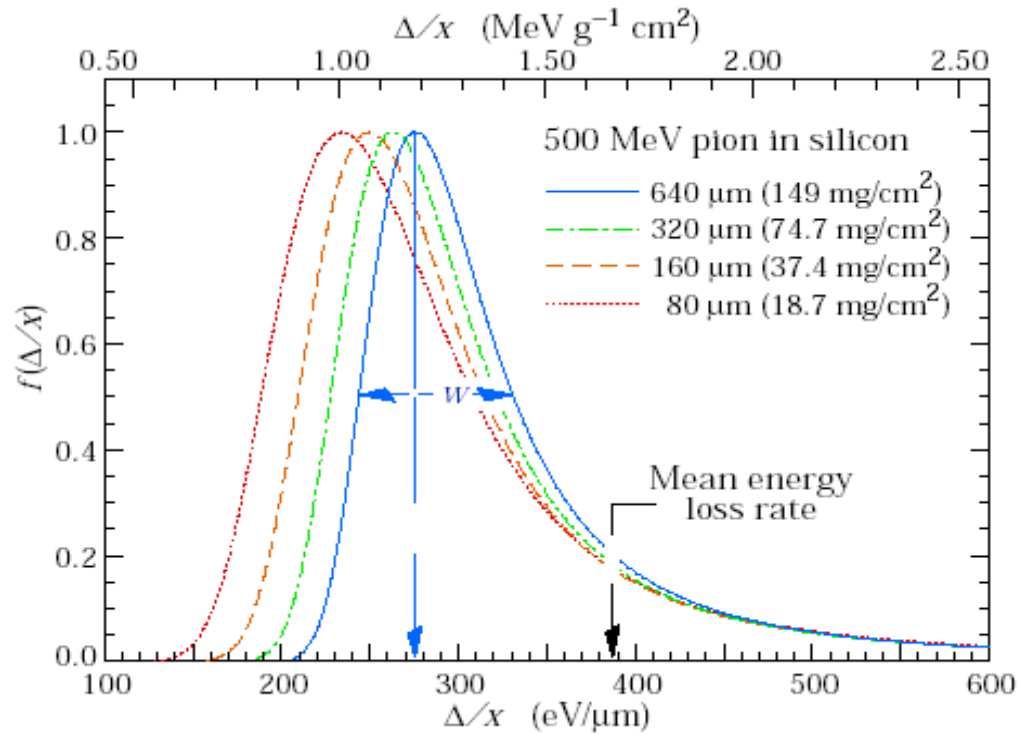

500 MeV pions in silicon. $W = \text{FWHM}$

Drift of ions

- In the absence of an electric field the ions rapidly lose energy by collisions with gas molecules.
- The diffusion follows a Gaussian distribution with an rms given by

$$\begin{aligned}\sigma_x &= \sqrt{2Dt} && \text{linear} \\ \sigma_V &= \sqrt{6Dt} && \text{volume}\end{aligned}$$

D is the diffusion coefficient ($0.34 \text{ cm}^2.\text{s}^{-1}$ for H_2 and $0.04 \text{ cm}^2.\text{s}^{-1}$ for Ar)

Drift of ions

- When an external electric field is applied a net movement along the field direction is observed.
- The *average* velocity is called the drift velocity w and is proportional to the reduced field E/P (up to quite high fields). It is useful to define the mobility $\mu = w/E$
- The mobility depends on the ion and the gas

Gas	Ion	Mobility ($\text{cm}^2 \cdot \text{V}^{-1} \cdot \text{s}^{-1}$)
Ar	Ar^+	1.7
Ar	CH_4^+	2.26
CO_2	CO_2^+	1.09
He	He^+	13.0

Drift of electrons

- When an external electric field is applied a net movement along the field direction is observed.
- The mobility of electrons is *not* constant with field.
- Electrons drift much more rapidly than ions, at high fields velocities of order $5 \text{ cm}/\mu\text{s}$ are typical which is about 1000 faster than typical ion drift velocities.

Ionisation

- Electrons can acquire enough energy between collisions to produce *inelastic* phenomena (for fields above a few kV/cm).
- The process of ionisation by collision is the basis of *avalanche* multiplication in proportional counters.
- High gains can be achieved, but getting stable operation requires mixtures of gases and the maximum practical gain is of order 10^6 .

The proportional counter

- Consider a co-axial detector consisting of a gas (or mixture of gases) between two cylinders.
- Apply a potential between the cylinders. The field is a maximum at the surface of the anode and decreases as $1/r$ towards the cathode.
- Produced charges drift towards the cathode and anode
- Close to the anode the field can be strong enough to allow significant gas multiplication (via the avalanche process).
- The electrons are rapidly collected and the ions drift back to the cathode.
- For gains up to about 10000 the collected charge is **proportional** to the charge originally deposited.
- At very high gains the gain becomes independent of the deposited charge – this is the Geiger-Muller region

Gas Ionization

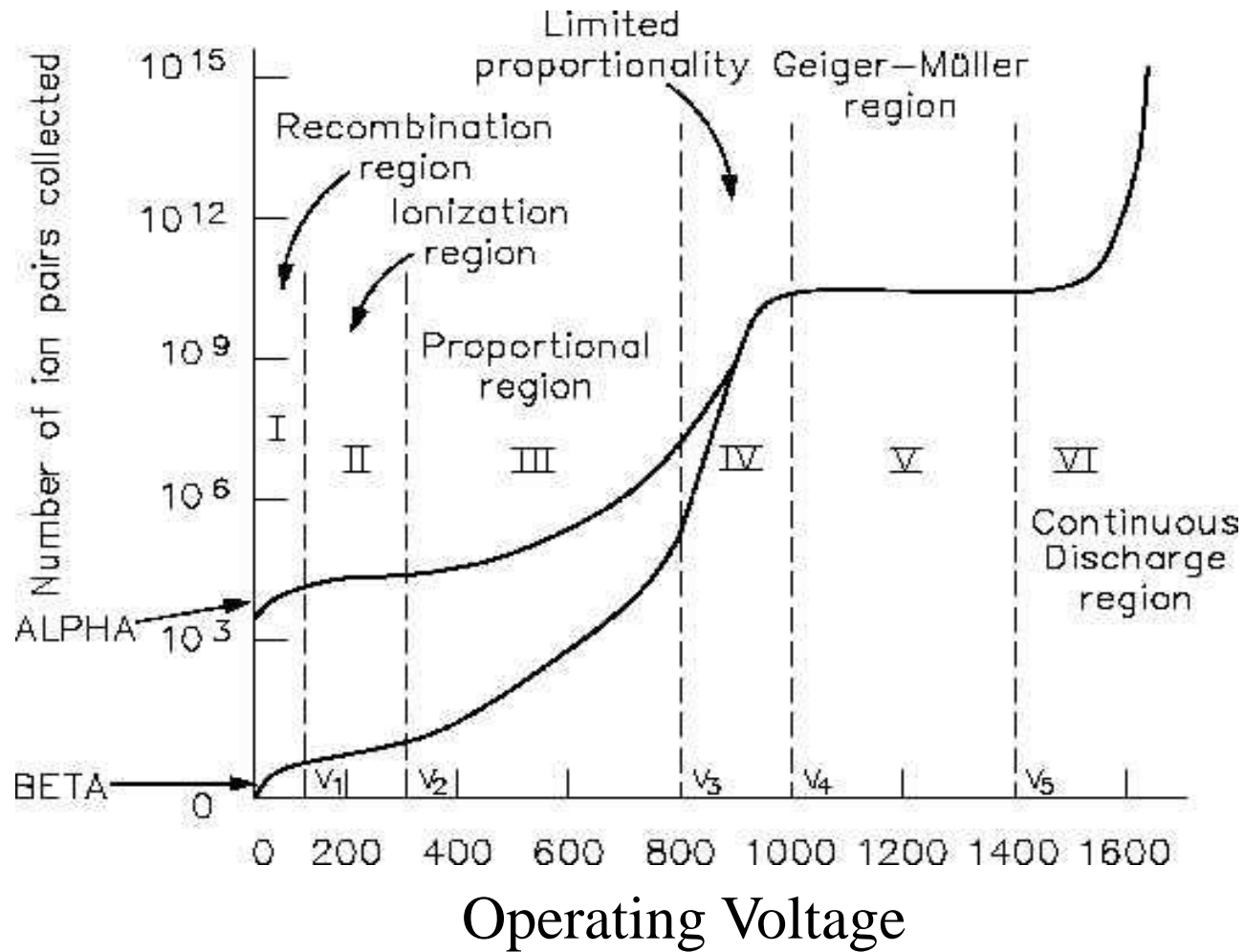

The Different Regions

- I Some recombination of the ions at $V < V_1$ due to slow drift velocity
- II No *gas amplification* but full collection
- III Gas amplification is proportional to operating voltage
- IV Townsend avalanche begins to spread along the anode wire
- V Geiger-Muller region: pulse height is now independent of particle type.

Gain

The figure (from Knoll) shows the gas multiplication factor for various proportional counters. Note the rapid change with voltage.

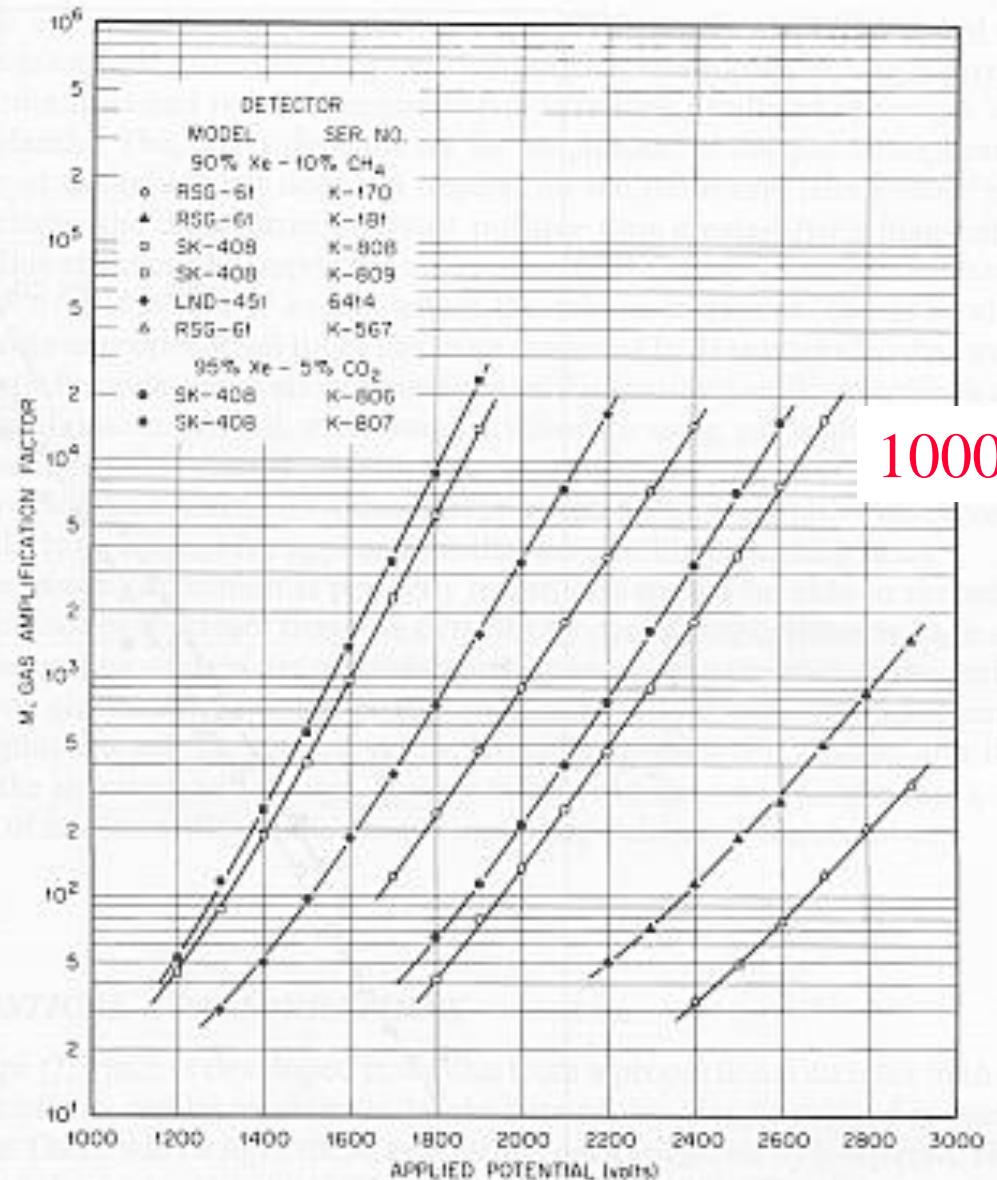

Figure 6.10 Variation of the gas multiplication factor M with voltage applied to various proportional counters. The tubes differ in their physical characteristics, but only the two indicated gases were used. (From Hendricks.⁴⁹)

Time development of the signal

- All the signal is due to the positive ions!
- This is because the induced signal for the electrons is tiny since they are produced very close (of order $1\mu\text{m}$) to the anode. The positive ions drift back across almost the whole diameter of the proportional counter.
- The maximum signal is thus achieved when all the positive ions are collected (of order 0.5 ms for typical geometries), however 50% of the signal is collected in about 500 ns.
- Normally terminate the counter with a resistance to quickly differentiate the signal with a time constant RC . A small value of R gives a good high rate capability.

MWPC

- Multi-wire proportional counters (MWPC) collect deposited charge in a large number of electrically isolated cells – position resolution
- By using planes of MWPC with orthogonal (and often diagonal) wire planes you get 2D hit resolution.

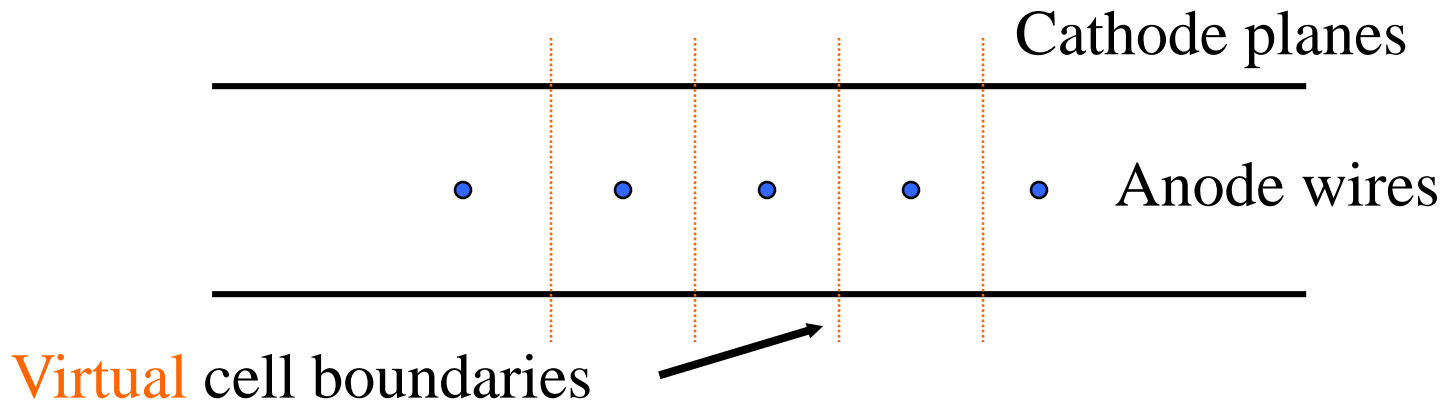

Electric Field in a MWPC

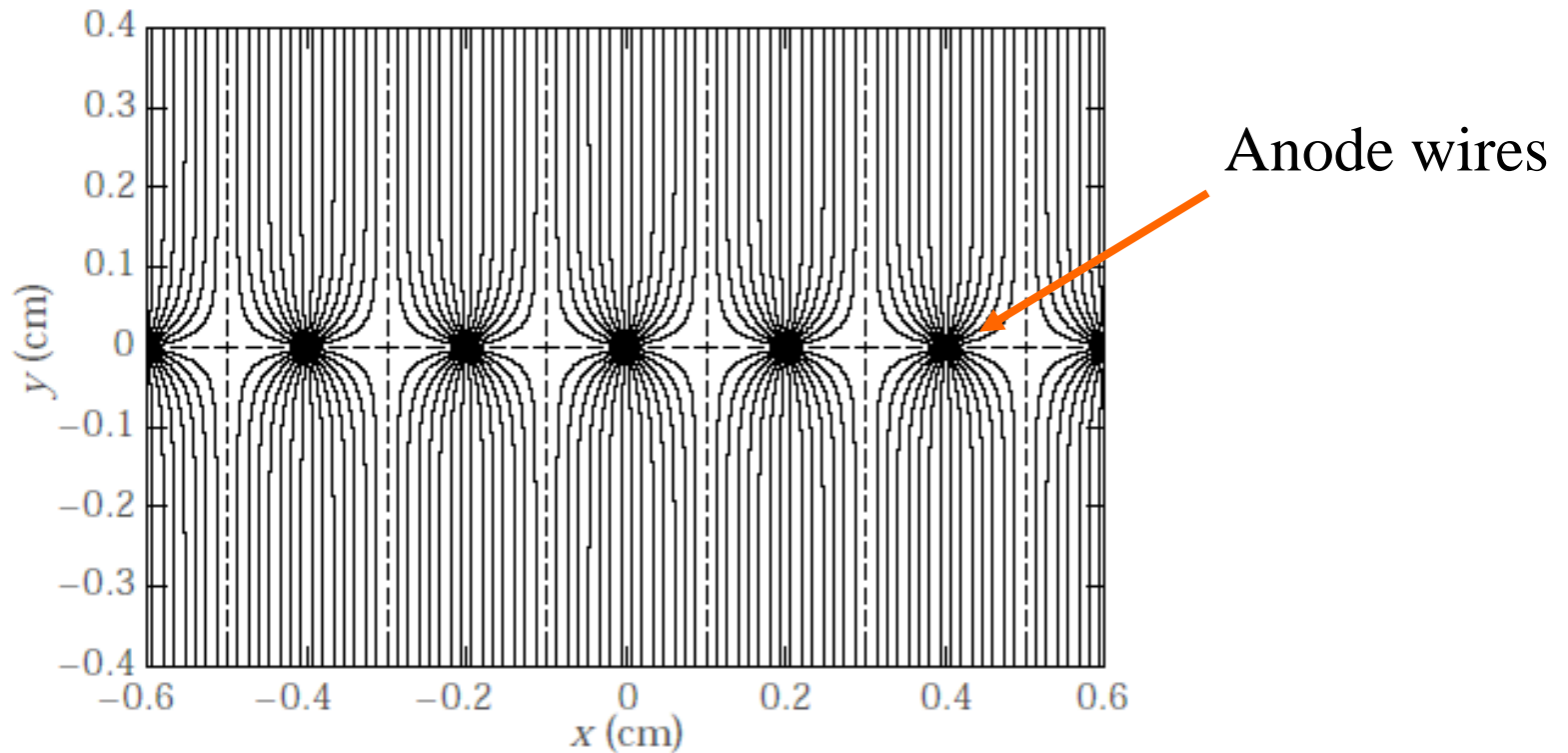

Drift Chamber

- In principle, since the electrons travel at a constant mean velocity, measuring this drift time gives spatial information.
- Could use a modified proportional counter with a long drift region.
- This design does not scale well (long drift times, very high voltages)

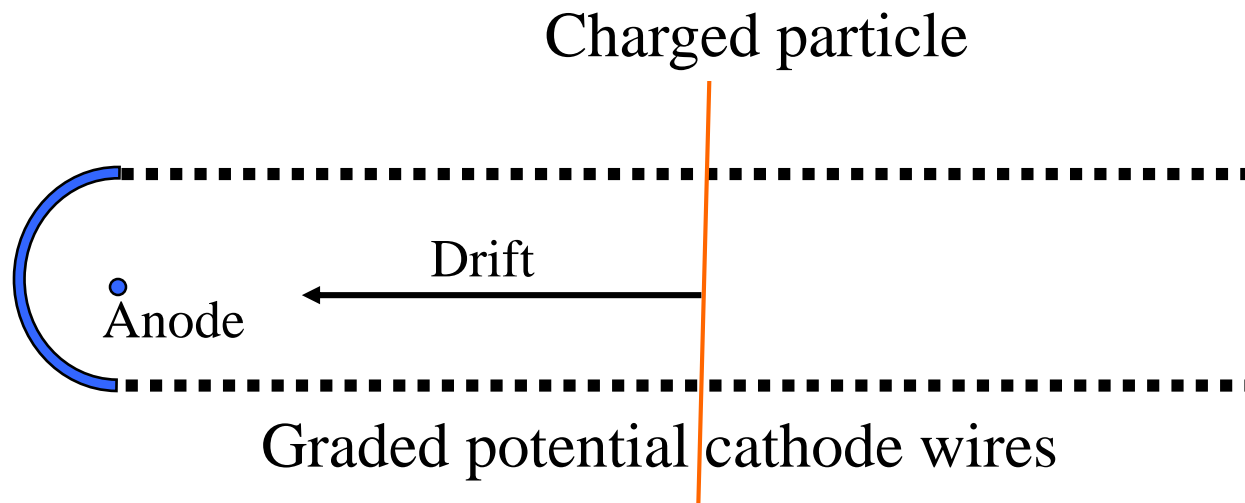

Drift Chamber

- The clever trick is to use the same structure as a MWPC but to avoid the significant field non-uniformities (low field between anodes) which would ruin the resolution.
- Instead of having all anode wires, a drift chamber alternates anode wires with *field* wires. These are thick and help maintain the electric field in the critical region.
- Localisation accuracy is limited by
 - Spread in original position of ionisation (delta-rays)
 - Stability of drift velocity
 - Dispersion due to diffusion
 - Localisation of order $20\ \mu\text{m}$ is achievable for a drift distance of 1 cm.

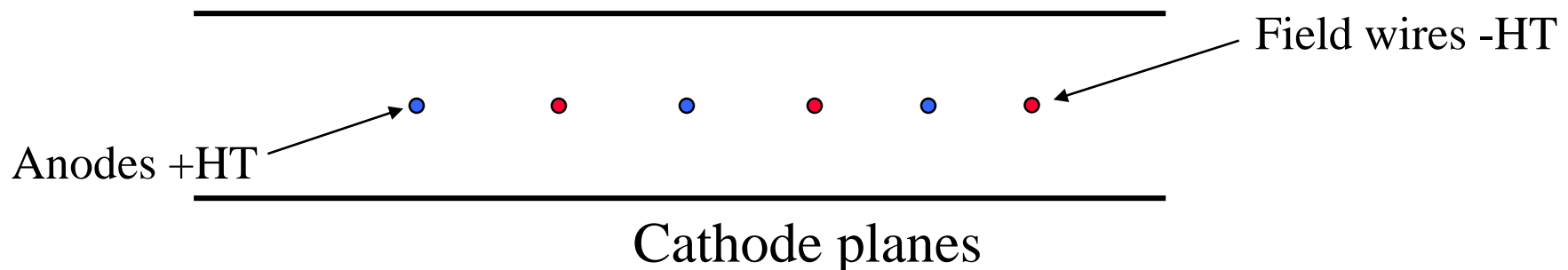

Microstrip

Figure (from *NIM A310 p89*) shows a gas microstrip detector.

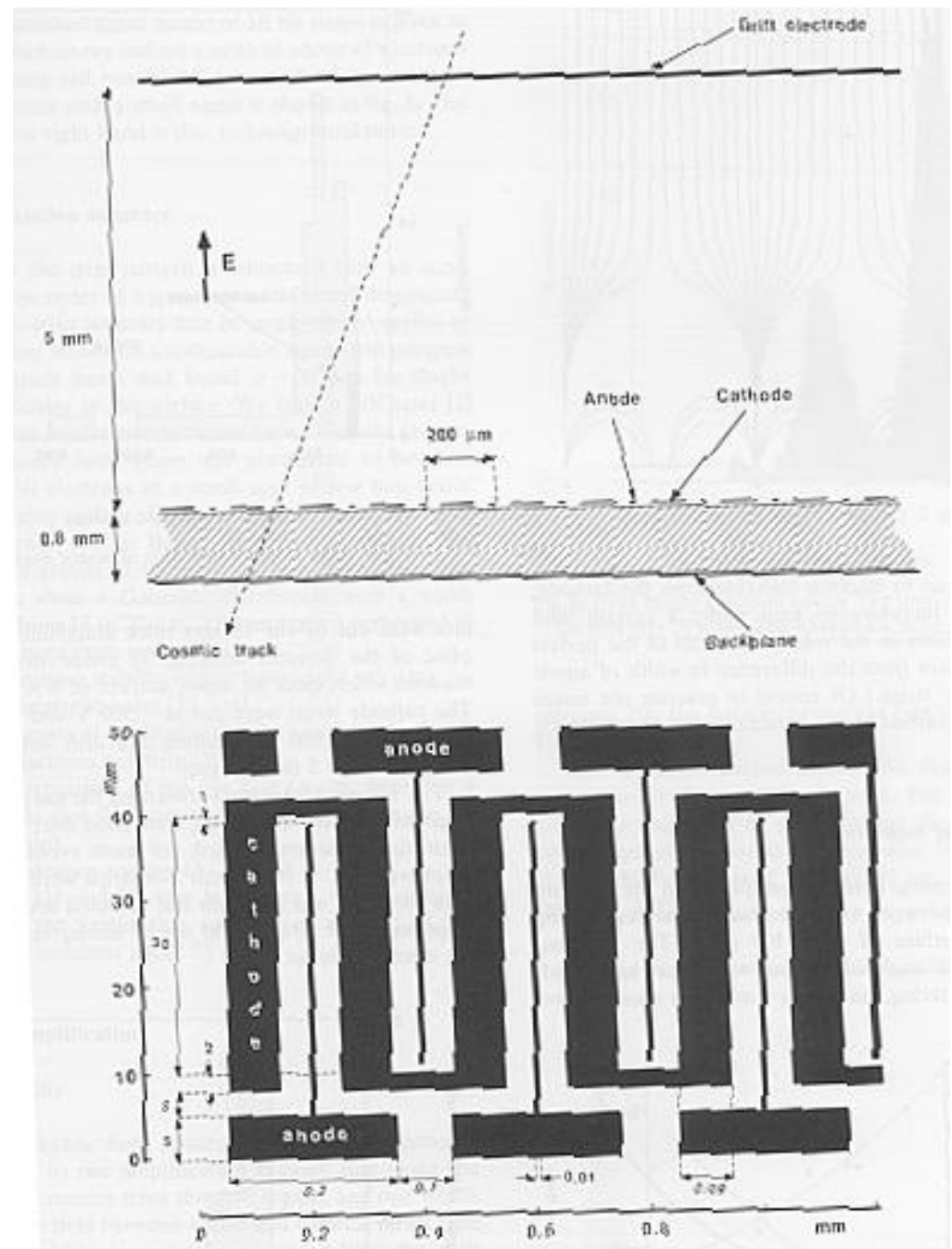

Electric Field in an MSGC

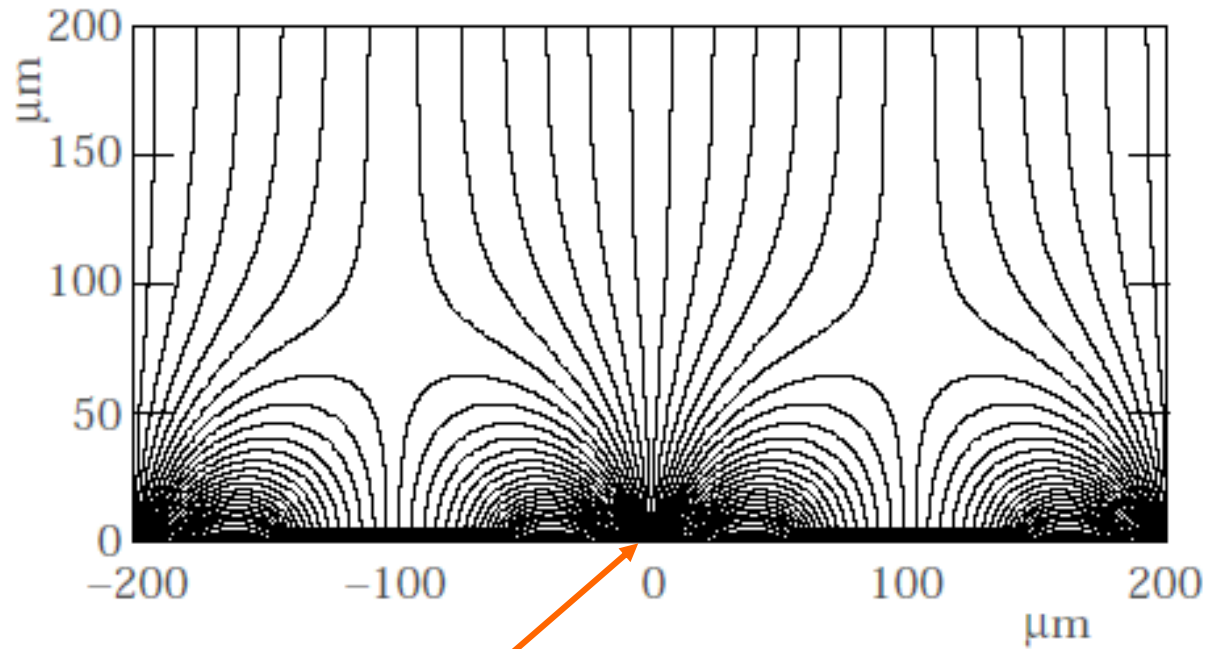

Anode strips

Large Area Detectors

Muon detectors in LHC GPD experiments such as ATLAS, CMS typically use gaseous detectors.

CMS has three different types, one for triggering (i.e. fast) and two used for the tracking.

Barrel uses Drift tubes, Endcap uses Cathode-Strip Chambers, Trigger uses **Resistive Plate Chambers (RPC)**

RPC

- Cheap, fast, simple design, large area.
- Typically uses the plastic “Bakelite” as the resistive material from which the parallel plates are made.
- “Moderate” insulator ($\sim 10^{10} \Omega\text{m}$ volume and $10^{11} \Omega$ surface resistivity)

Bakelite



Ericsson telephone, picture by Holger Elgaard
Licensed under the [Creative Commons Attribution-Share Alike 3.0 Unported](https://creativecommons.org/licenses/by-sa/3.0/)

Double Gap RPC

J. Phys. G: Nucl. Part. Phys. **26** (2000) 1291

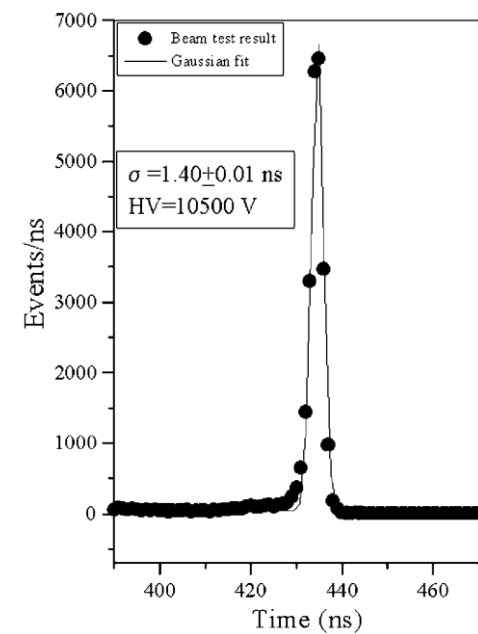
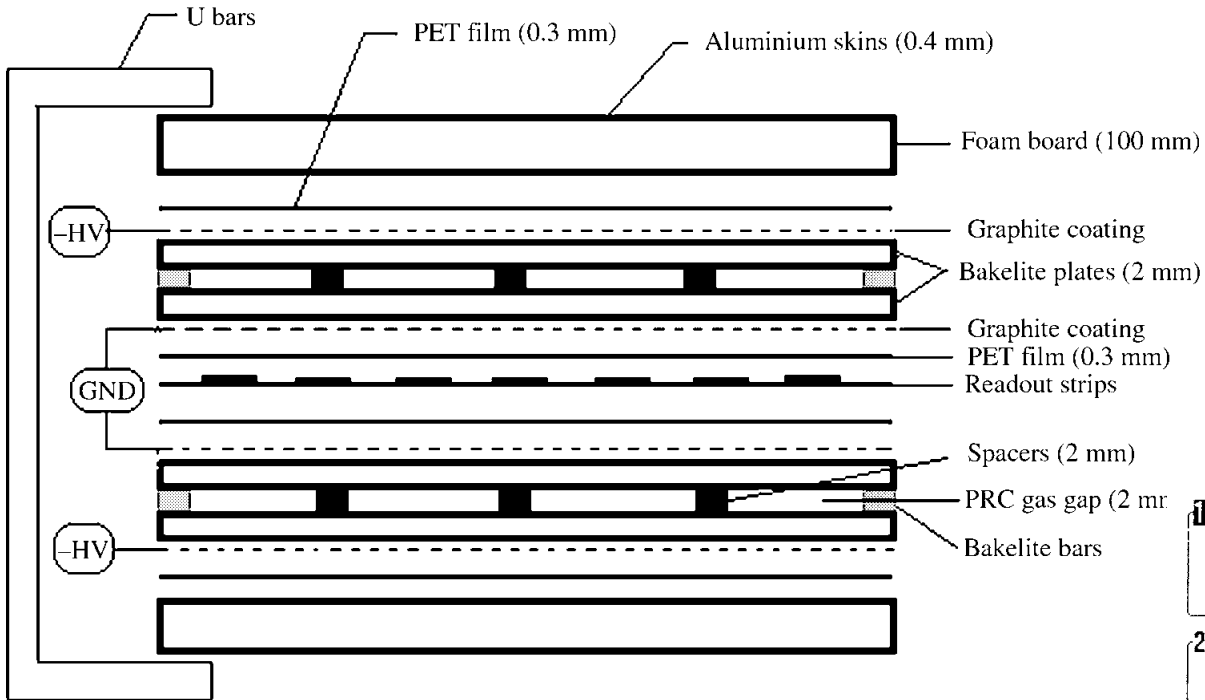

Gas mixture of 95% $C_2H_2F_4$ + 5% $i-C_4H_{10}$

1
0.1 μ s
2.00 mV

2
0.1 μ s
1.00 V

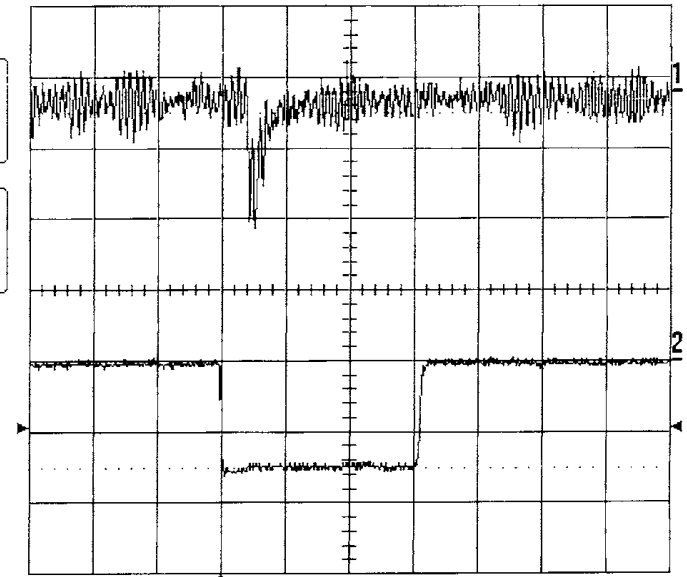

1 2 mV DC
2 1 V DC
3 0.5 V 50 Ω
4 0.5 V 50 Ω

Store to floppy
Size 1440 K Free 1388 K
Directory LECROY_1.DIR
2 GS/s
STOPPED

Huge system! $\sim 3000 \text{ m}^2$
and 100 k channels

RPC in CMS

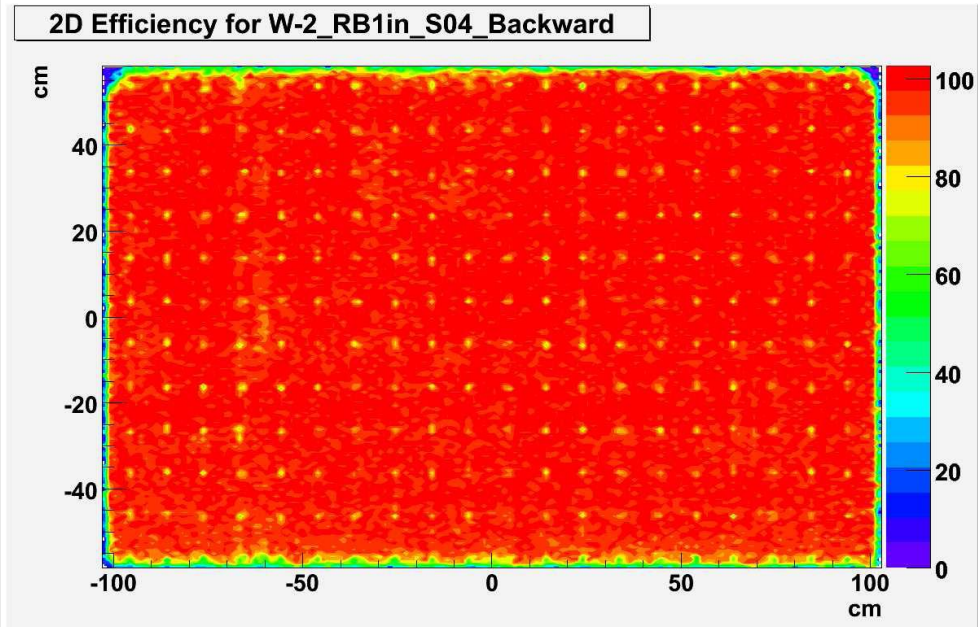
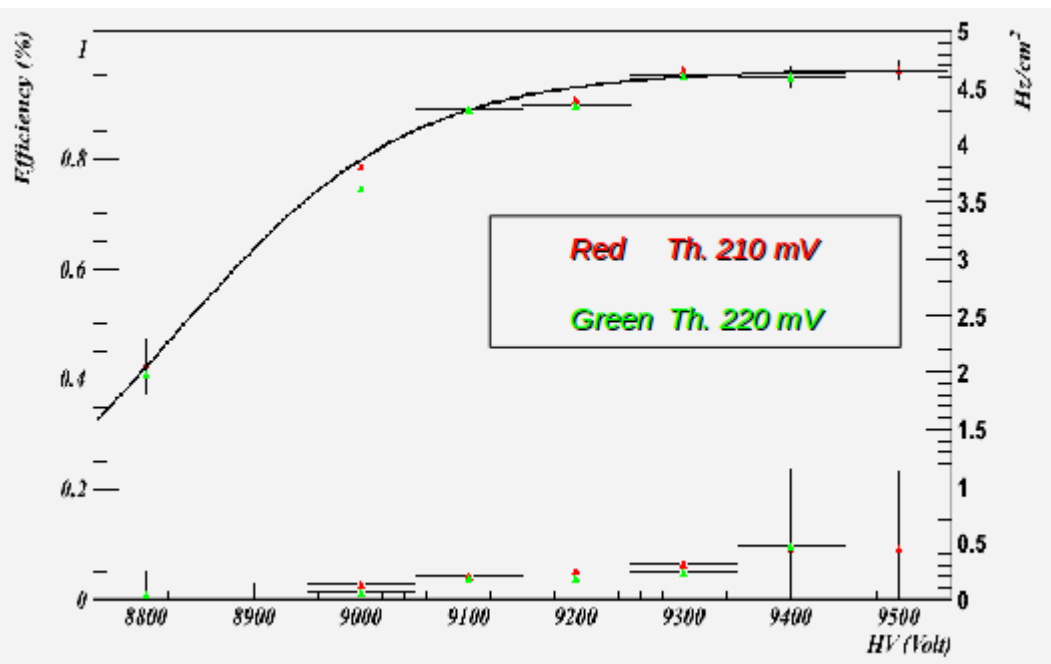

Efficiency as function of
HV

Local efficiency
of 1 chamber

Spatial
resolution

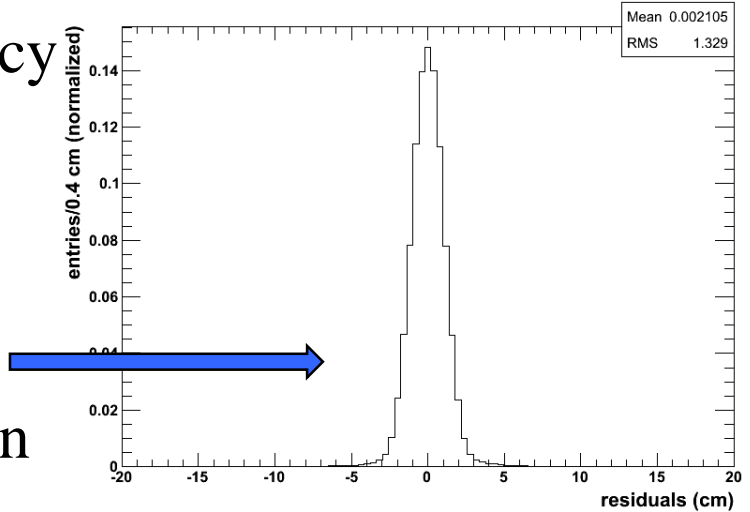

ATLAS & CMS plan RPC upgrades

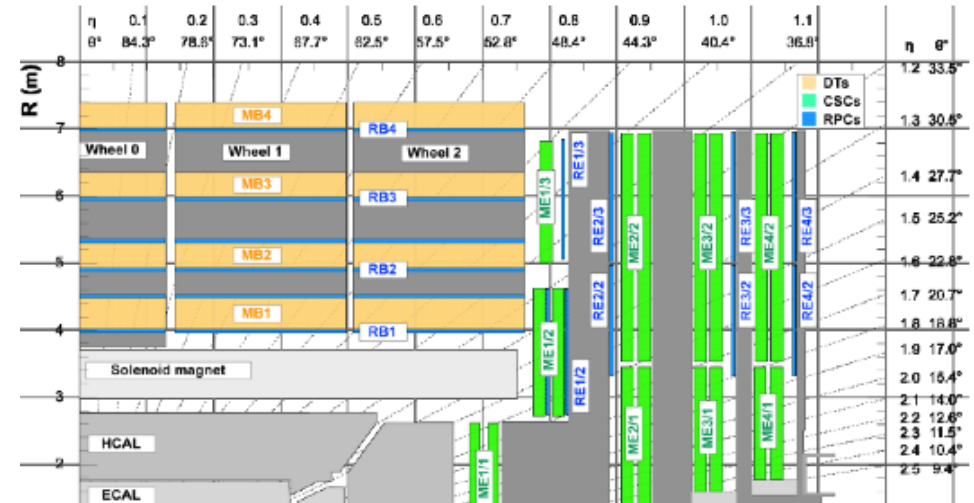
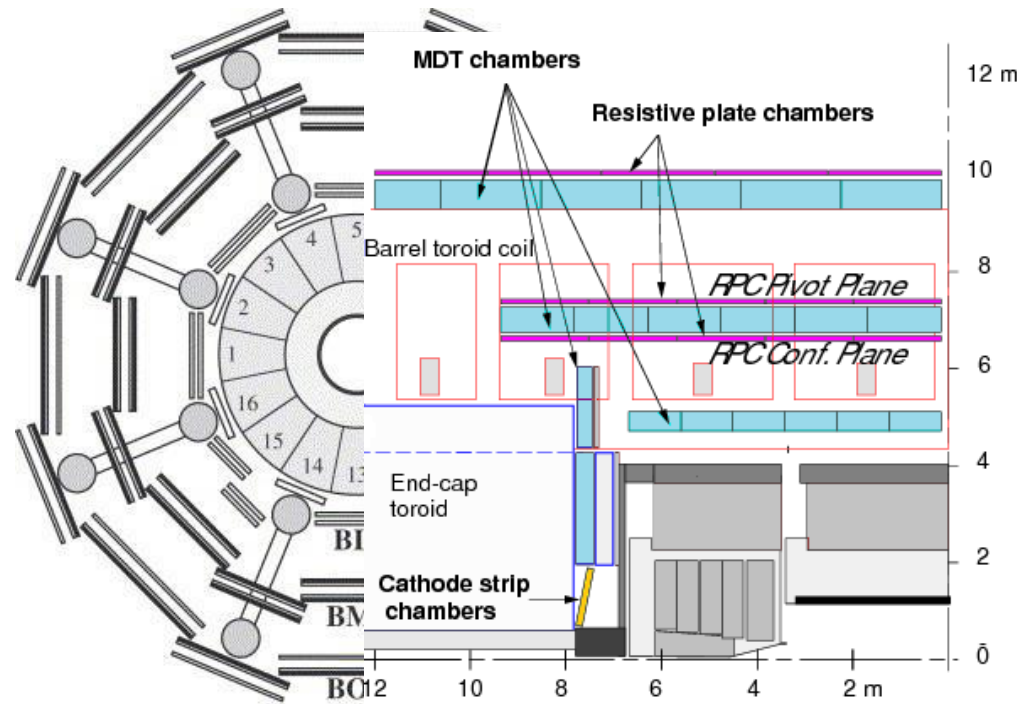

See talk by R. Santonico at ECFA 2014 meeting in Aix les Bains on Indico

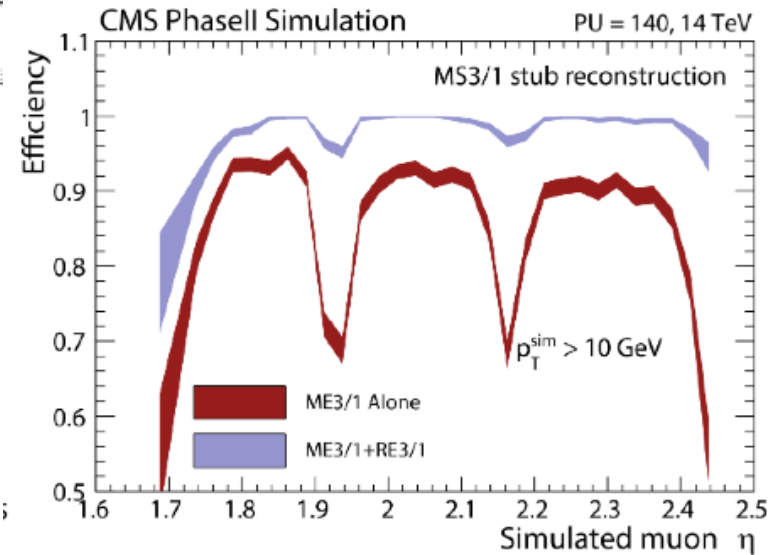

Time Projection Chamber

Giant drift chamber with no wires inside the main volume.

Read out with MWPC on the two end plates (e.g. ALICE TPC)

Provides tracking with high spatial resolution and very small number of X_0

Economic number of channels,

Needs fast readout and trigger (e.g. BX) to generate the z-coordinate

ALICE has the world's largest TPC

CERN/LHCC 2000–001

ACTA PHYSICA POLONICA B, **42** (2011) 1401

ALICE TPC General layout

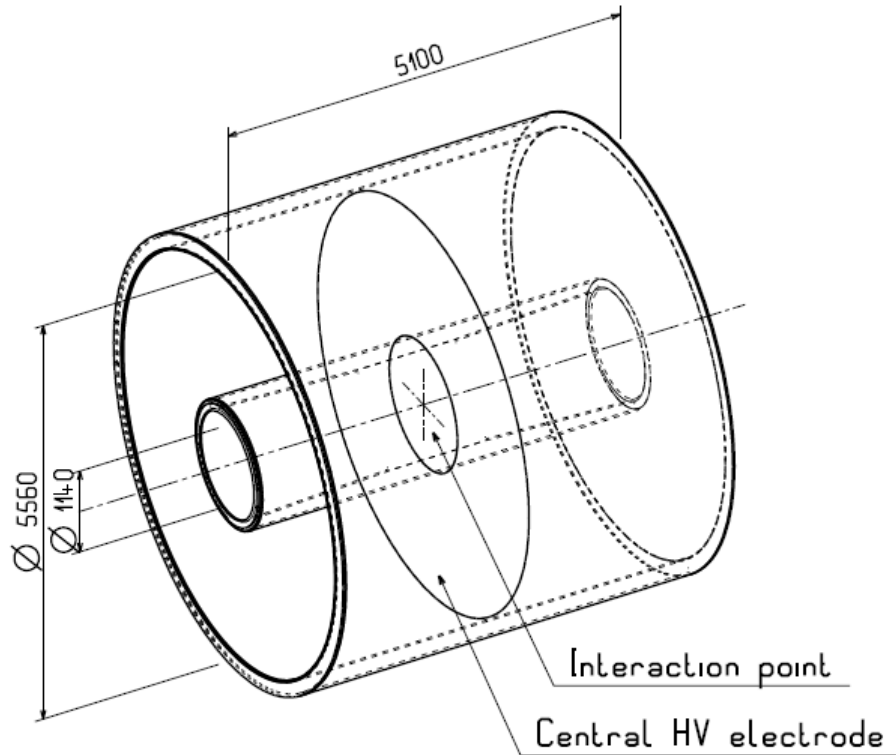

Figure 3.1: Conceptual view of the TPC field cage.

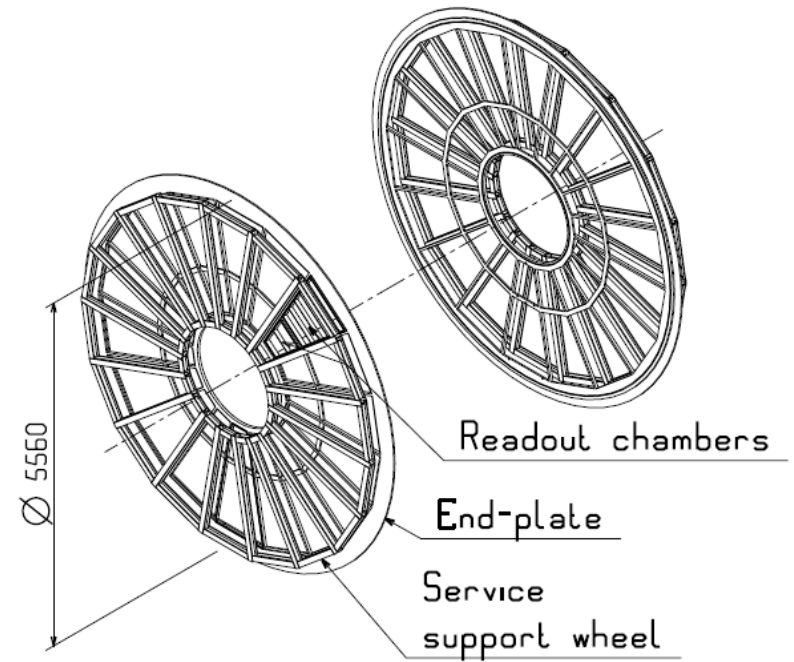
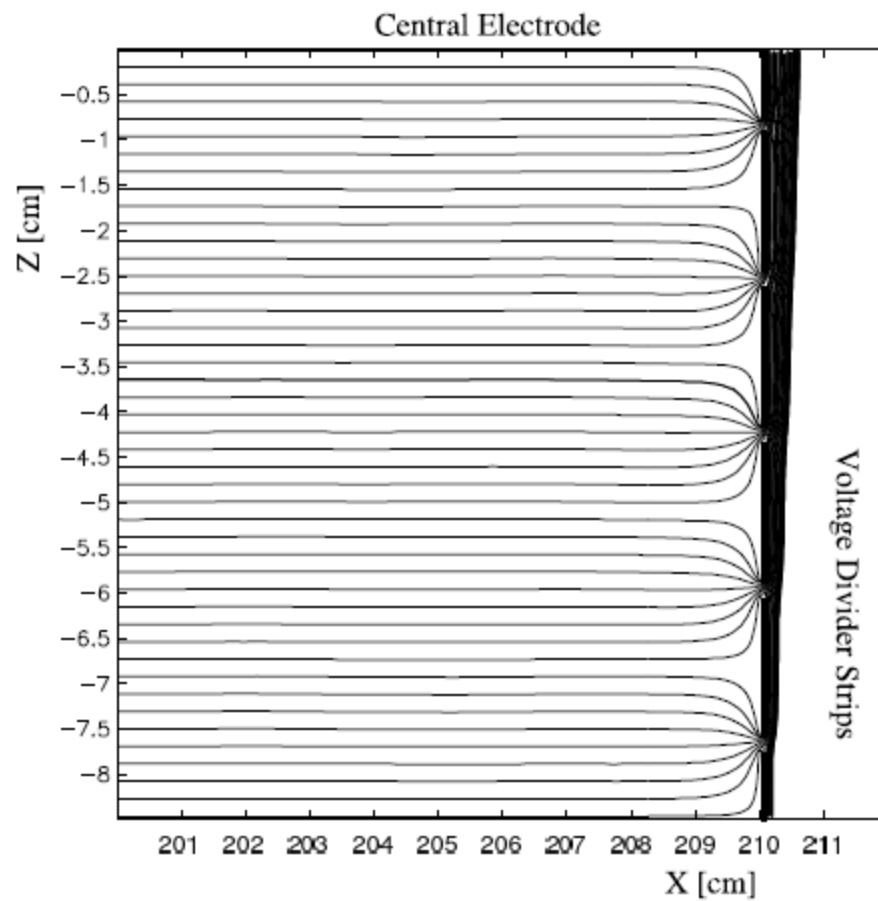
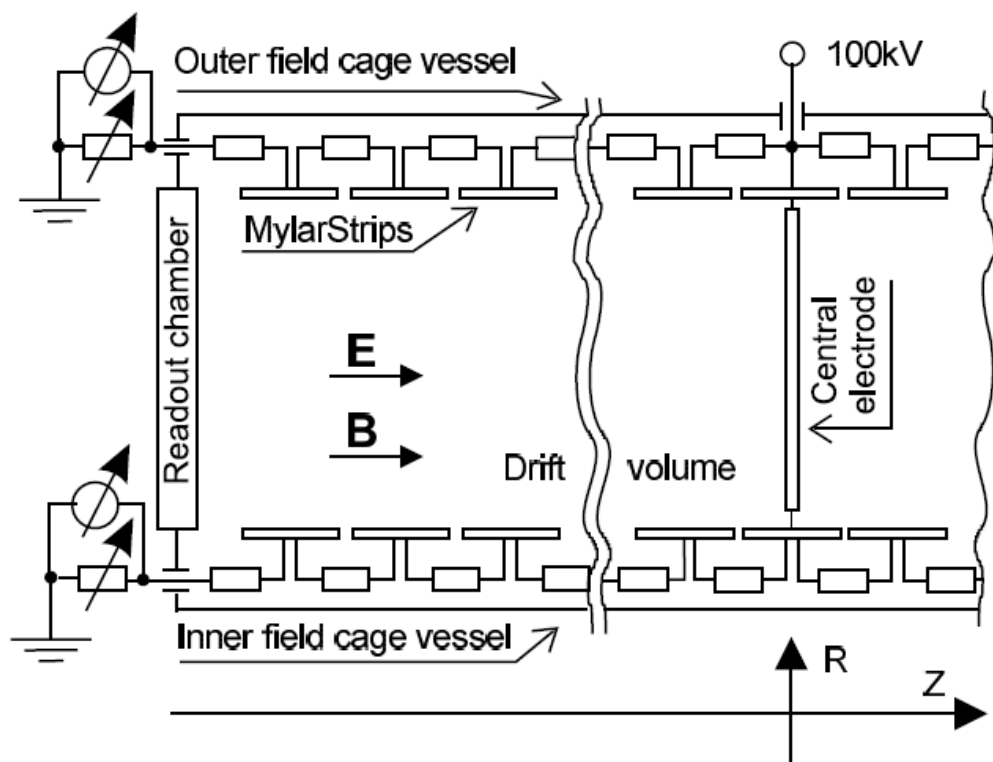

Figure 3.8: Design of the end-plate and the service support wheel.

Field



ALICE TPC



Mainly filled with neon; gas volume 90 m³.

Read out with MWPC using pads (560k).

MWPC gas gain $\sim 10^4$

System monitored using UV laser

ALICE TPC monitoring

Side A

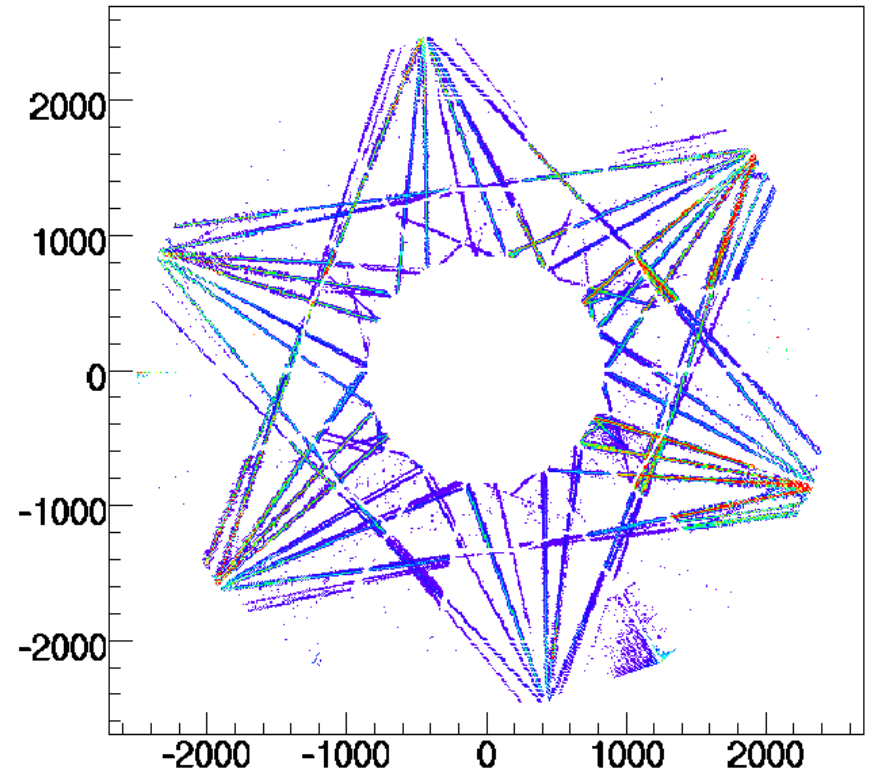
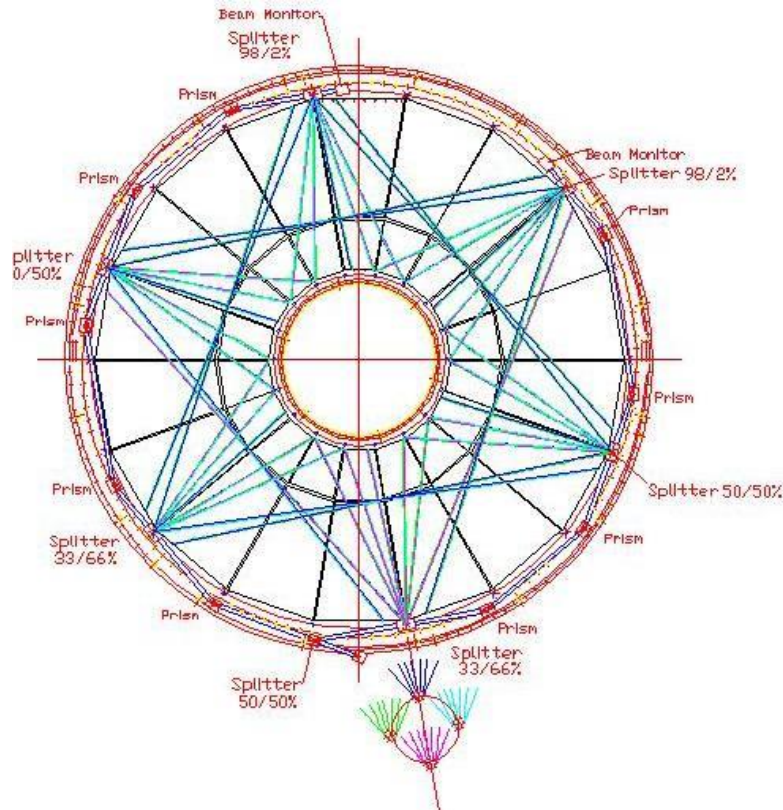

266 nm, 5 ns, UV laser beams traversing the active volume of the TPC. Note that it is very low levels of organic impurities that are being ionised here, not the Ne/CO₂/N₂ drift gas mixture.

See the HEHI group at Niels Bohr Inst. Copenhagen for more information

Cosmic shower

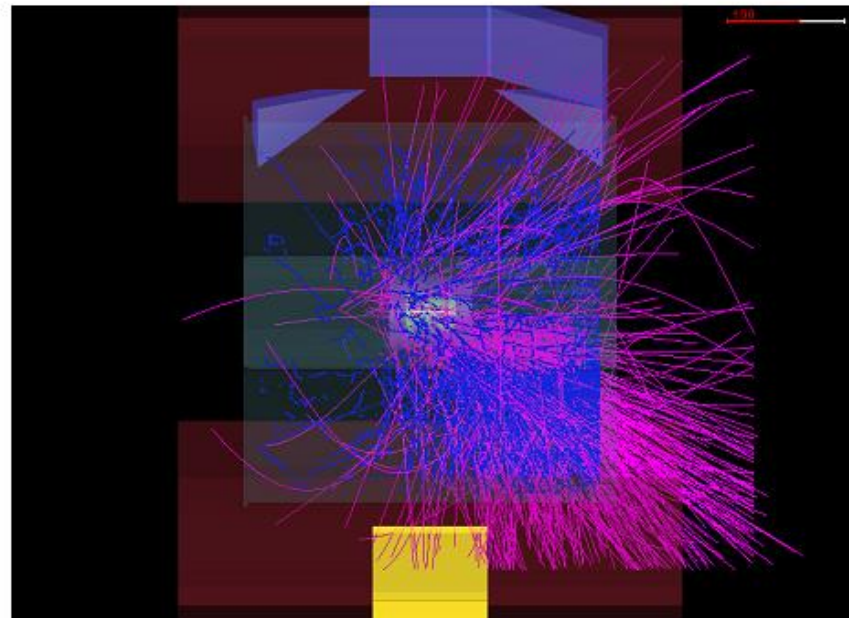
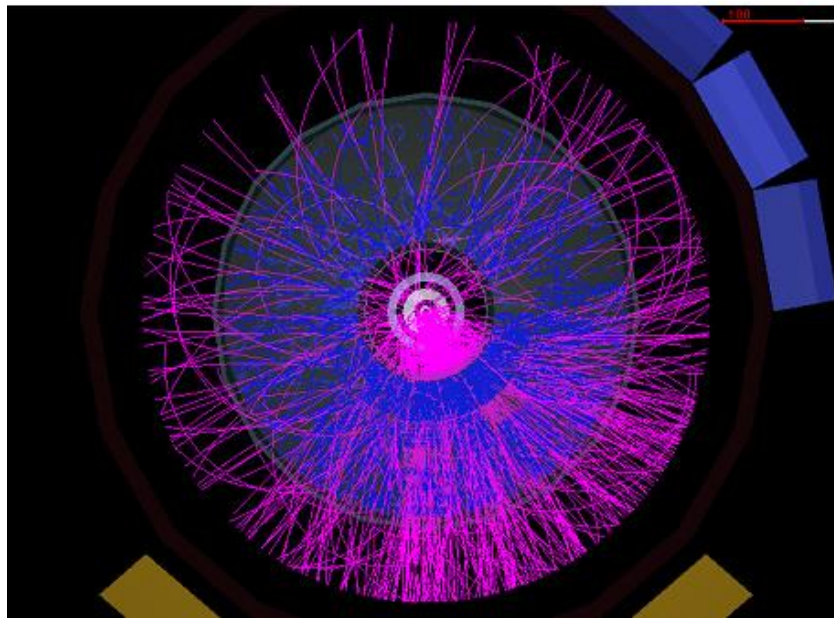
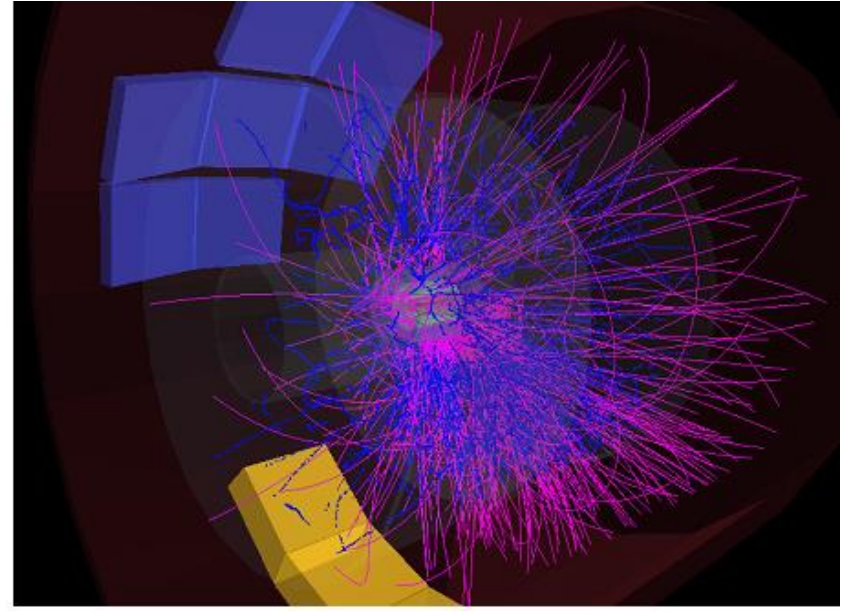
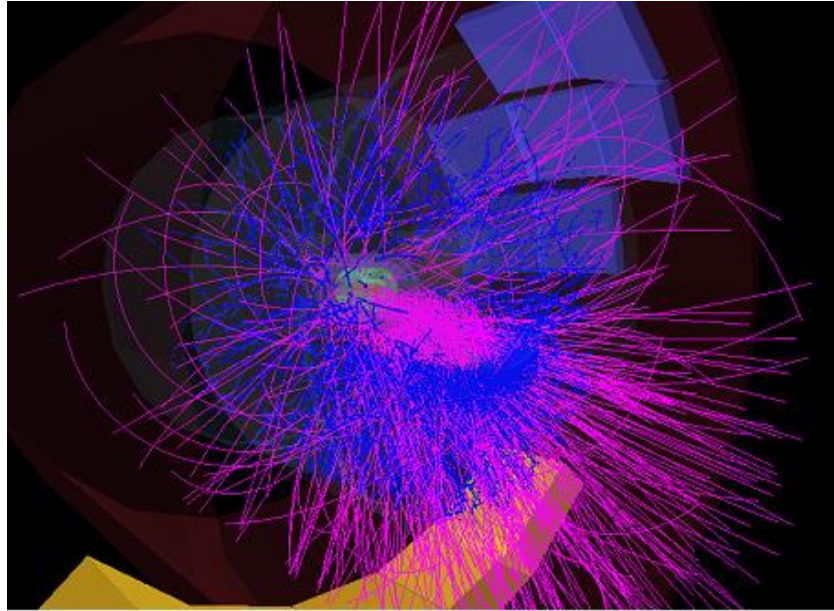

Performance

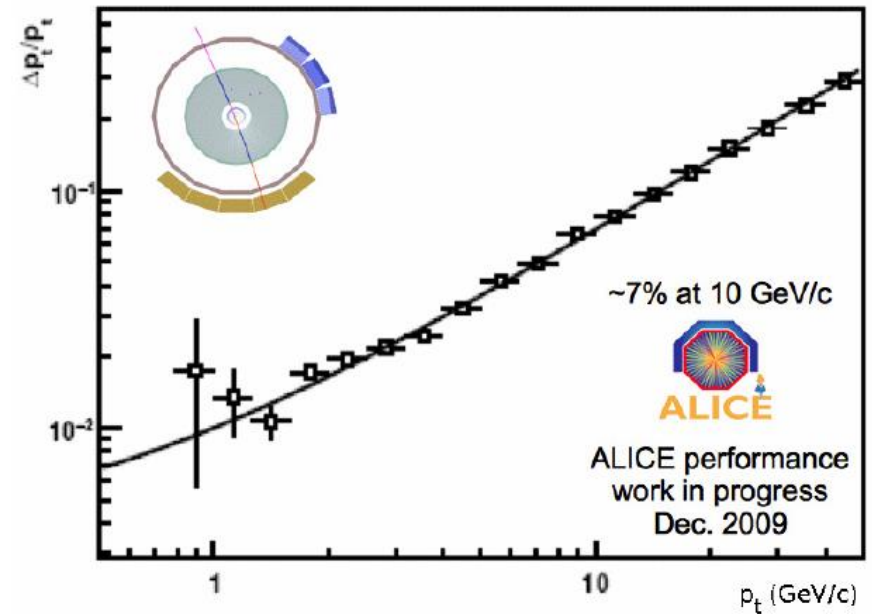
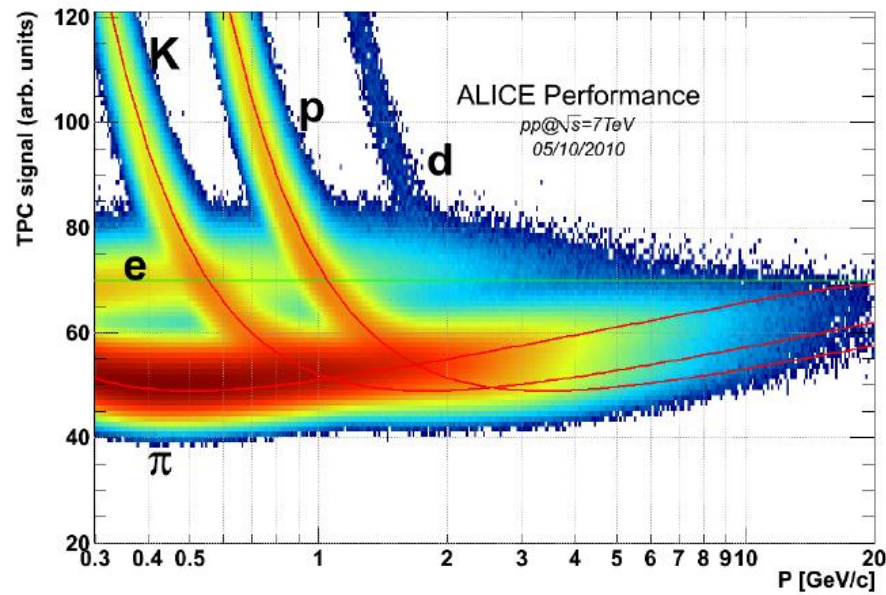

Fig. 1. TPC signal as a function of momentum in pp collisions at 7 TeV.